

Higher-Order $\Delta\Sigma$ Modulators and the $\Delta\Sigma$ Toolbox

Richard Schreier
richard.schreier@analog.com

NLCOTD: Dynamic Flip-Flop

- Standard CMOS version

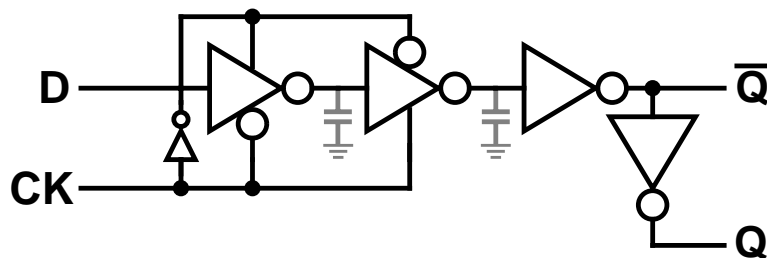

- Can the circuit be simplified?
Is a complementary clock necessary?

Review: A $\Delta\Sigma$ ADC System

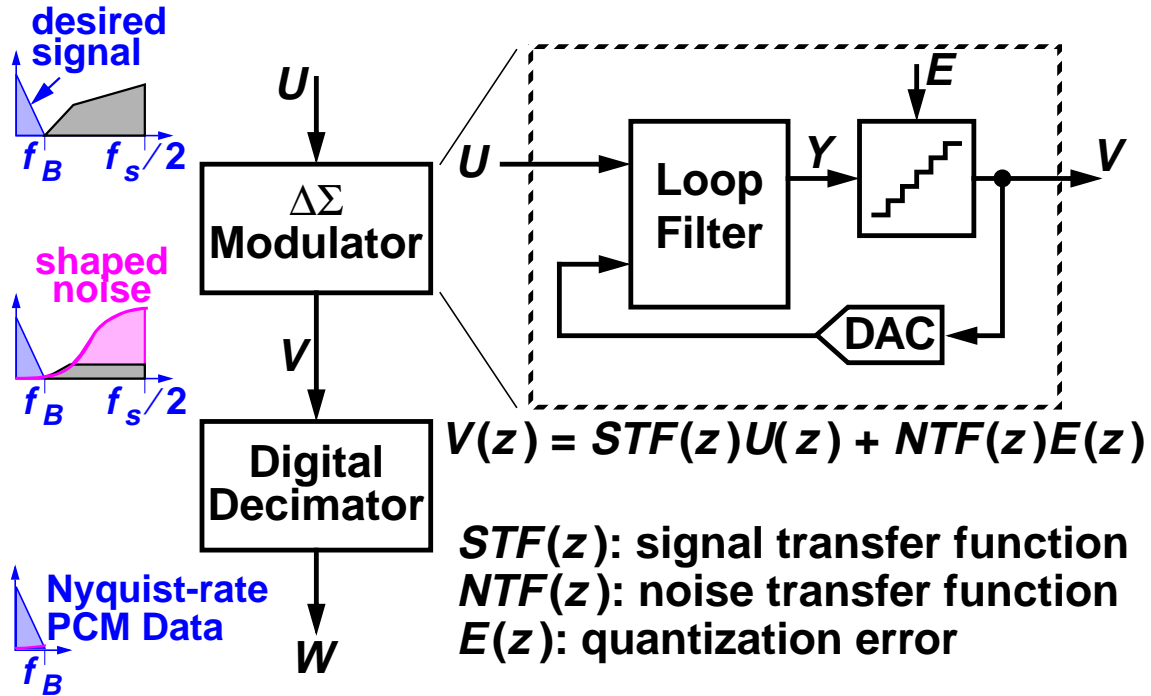

ECE1371

3

Review: MOD1

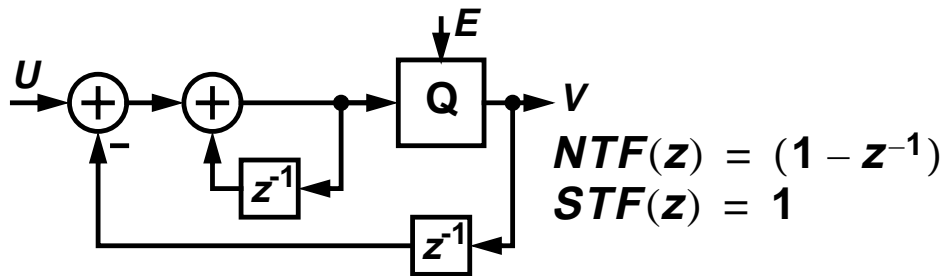

NTF poles & zeros:

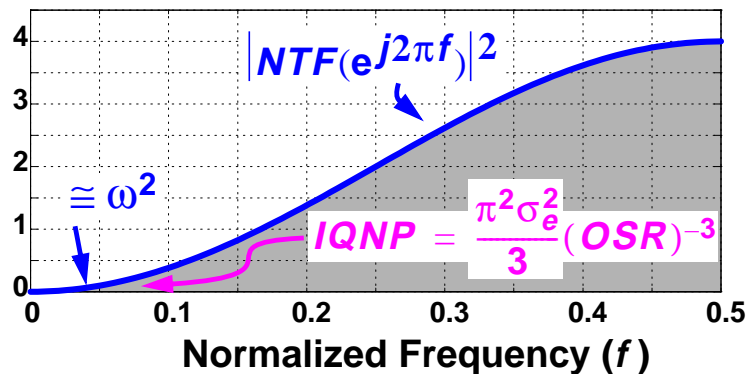
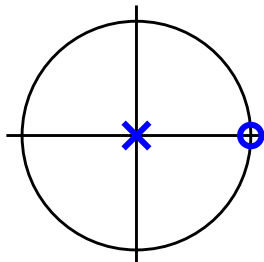

ECE1371

4

Review: MOD2

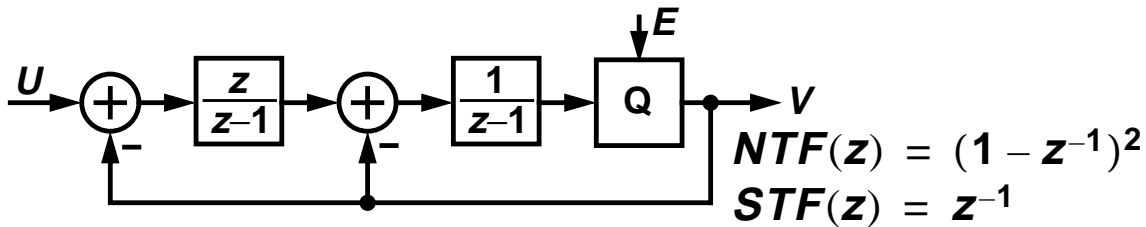

NTF poles & zeros:

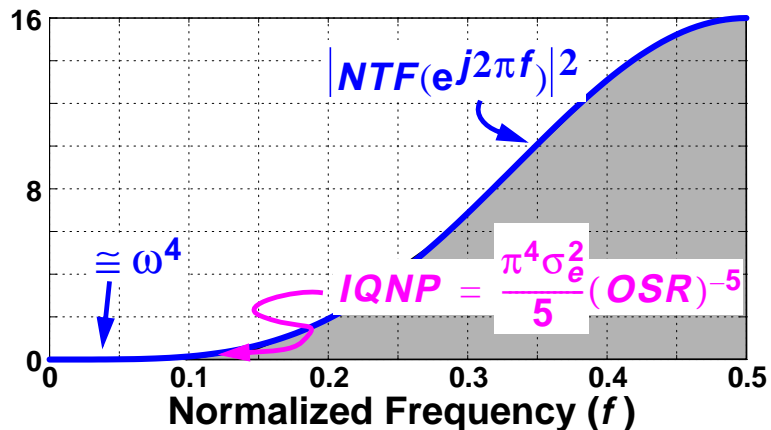
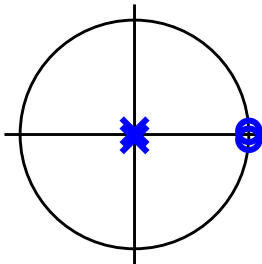

ECE1371

5

Review Summary

- $\Delta\Sigma$ works by spectrally separating the quantization noise from the signal
 Requires oversampling. $OSR \equiv f_s / (2f_B)$.
 Achieved by the use of *filtering* and *feedback*.
- A binary DAC is *inherently linear*, and thus a binary $\Delta\Sigma$ modulator is too
- MOD1-CT has *inherent anti-aliasing*
- MOD1 has $NTF(z) = 1 - z^{-1}$
 \Rightarrow Arbitrary accuracy for DC inputs;
 9 dB/octave SQNR-OSR trade-off.
- MOD2 has $NTF(z) = (1 - z^{-1})^2$
 \Rightarrow 15 dB/octave SQNR-OSR trade-off.

ECE1371

6

MODN

[Ch. 4 of Schreier & Temes]

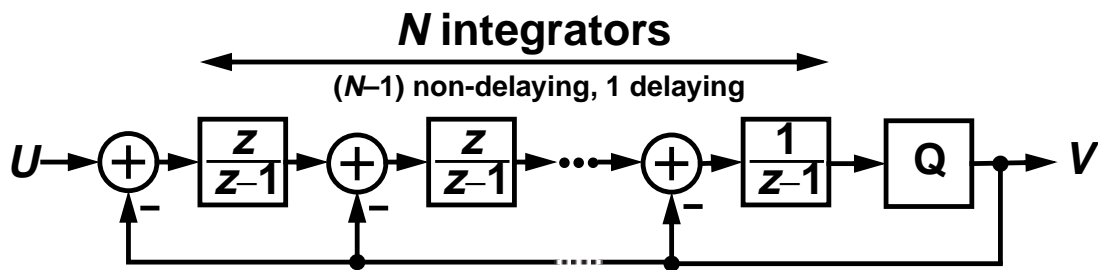

$$STF(z) = z^{-1}$$

$$NTF(z) = (1 - z^{-1})^N$$

- MODN's NTF is the N^{th} power of MOD1's NTF

ECE1371

7

NTF Comparison

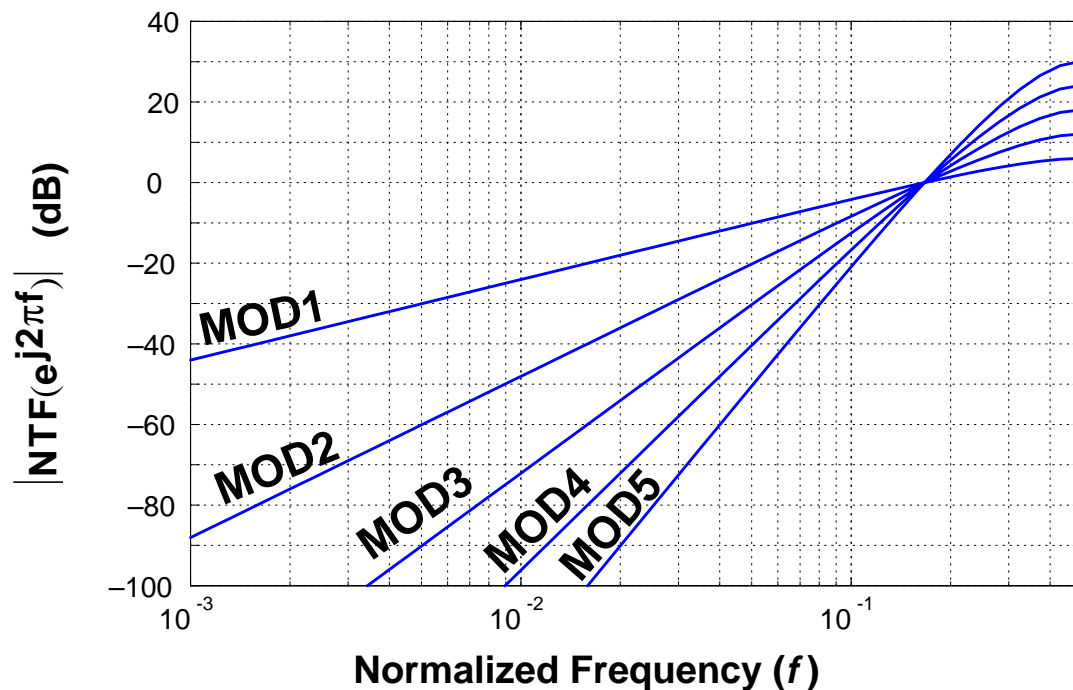

ECE1371

8

Predicted Performance

- In-band quantization noise power

$$\begin{aligned}
 IQNP &= \int_0^{0.5/OSR} |NTF(e^{j2\pi f})|^2 \cdot S_{ee}(f) df \\
 &\approx \int_0^{0.5/OSR} (2\pi f)^{2N} \cdot 2\sigma_e^2 df \\
 &= \frac{\pi^{2N}}{(2N+1)(OSR)^{2N+1}} \sigma_e^2
 \end{aligned}$$

- Quantization noise drops as the $(2N+1)^{\text{th}}$ power of OSR— $(6N+3)$ dB/octave SQNR-OSR trade-off

ECE1371

9

Improving NTF Performance— NTF Zero Optimization

- Minimize the integral of $|NTF|^2$ over the passband

Normalize passband edge to 1 for ease of calculation:

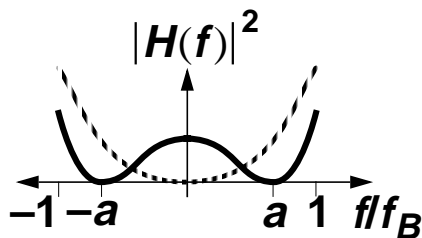

Need to find the a_i which minimize the integral

$$\begin{aligned}
 &\int_{-1}^1 (x^2 - a_1^2)^2 dx, & n = 2 \\
 &\int_{-1}^1 x^2 (x^2 - a_1^2)^2 dx, & n = 3 \\
 &\int_{-1}^1 (x^2 - a_1^2)^2 (x^2 - a_2^2)^2 dx, & n = 4 \\
 &\vdots
 \end{aligned}$$

ECE1371

10

Solutions Up to Order = 8

Order	Optimal Zero Placement Relative to f_B	SQNR Improvement
1	0	0 dB
2	$\pm 1/\sqrt{3}$	3.5 dB
3	0, $\pm\sqrt{3/5}$	8 dB
4	$\pm\sqrt{3/7} \pm \sqrt{(3/7)^2 - 3/35}$	13 dB
5	0, $\pm\sqrt{5/9} \pm \sqrt{(5/9)^2 - 5/21}$ [Y. Yang]	18 dB
6	$\pm 0.23862, \pm 0.66121, \pm 0.93247$	23 dB
7	0, $\pm 0.40585, \pm 0.74153, \pm 0.94911$	28 dB
8	$\pm 0.18343, \pm 0.52553, \pm 0.79667, \pm 0.96029$	34 dB

ECE1371

11

Topological Implication

- Feedback around pairs integrators:

2 Delaying Integrators

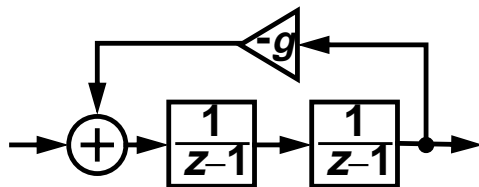

Poles are the roots of

$$1 + g\left(\frac{1}{z-1}\right)^2 = 0$$

i.e. $z = 1 \pm j\sqrt{g}$

Not quite on the unit circle,
but fairly close if $g \ll 1$.

Non-delaying + Delaying Integrators (LDI Loop)

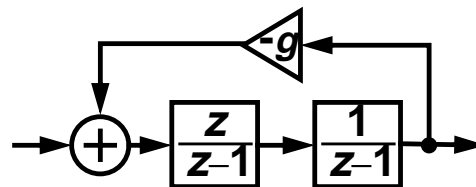

Poles are the roots of

$$1 + \frac{gz}{(z-1)^2} = 0$$

i.e. $z = e^{\pm j\theta}$, $\cos \theta = 1 - g/2$

Precisely on the unit circle,
regardless of the value of g .

ECE1371

12

Problem: A High-Order Modulator Wants a Multi-bit Quantizer

E.g. MOD3 with an Infinite Quantizer
and Zero Input

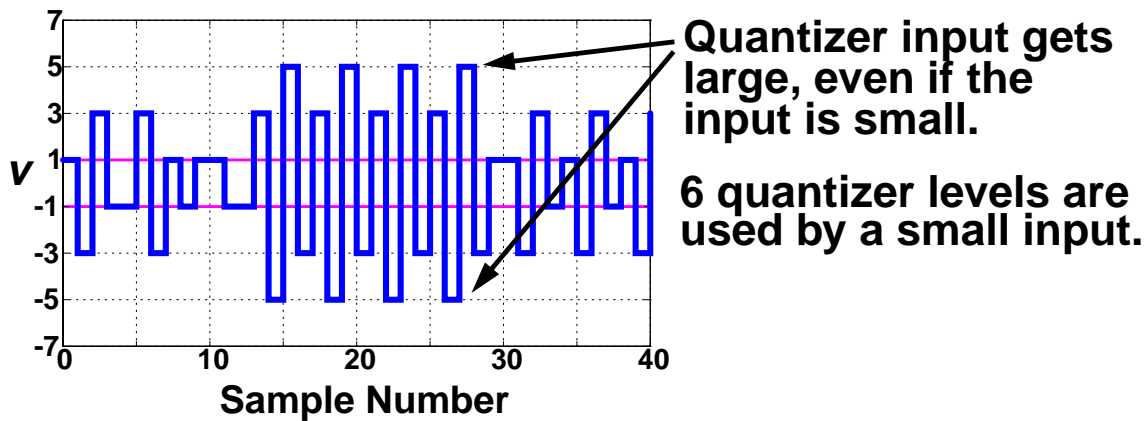

ECE1371

13

Simulation of MOD3-1b (MOD3 with a Binary Quantizer)

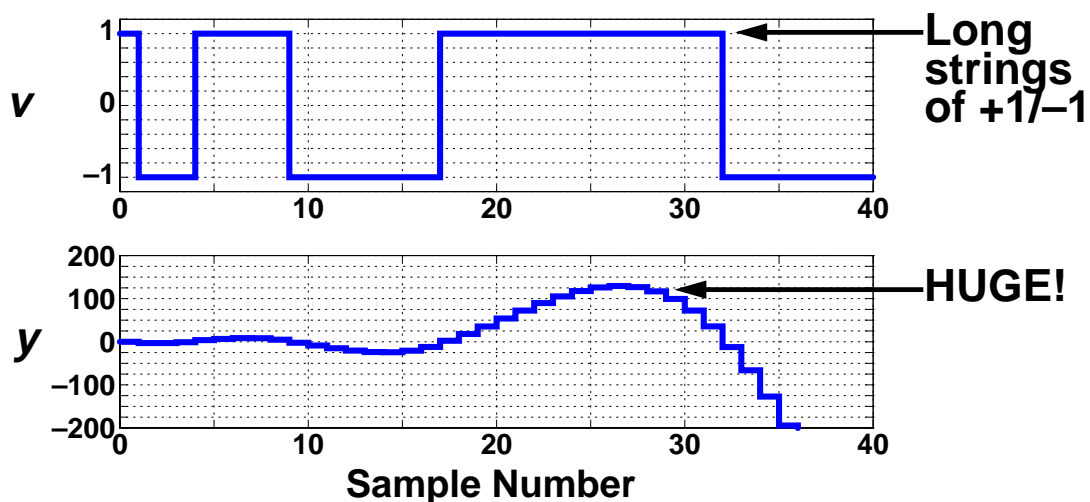

- MOD3-1b is unstable, even with zero input!

ECE1371

14

Solutions to the Stability Problem

Historical Order

1 Multi-bit quantization

Initially considered undesirable because we lose the inherent linearity of a 1-bit DAC.

2 More general NTF (not pure differentiation)

Lower the NTF gain so that quantization error is amplified less.

Unfortunately, reducing the NTF gain reduces the amount by which quantization noise is attenuated.

3 Multi-stage (MASH) architecture

- Combinations of the above are possible

ECE1371

15

Multi-bit Quantization

A modulator with $NTF = H$ and $STF = 1$ is guaranteed to be stable if $|u| < u_{max}$ at all times, where $u_{max} = nlev + 1 - \|h\|_1$ and $\|h\|_1 = \sum_{i=0}^{\infty} |h(i)|$

- In MODN $H(z) = (1 - z^{-1})^N$, so $h(n) = \{1, -a_1, a_2, -a_3, \dots, (-1)^N a_N, 0 \dots\}$, $a_i > 0$ and thus $\|h\|_1 = H(-1) = 2^N$
- $nlev = 2^N$ implies $u_{max} = nlev + 1 - \|h\|_1 = 1$
MODN is guaranteed to be stable with an N -bit quantizer if the input magnitude is less than $\Delta/2 = 1$.
This result is quite conservative.
- Similarly, $nlev = 2^{N+1}$ guarantees that MODN is stable for inputs up to 50% of full-scale

ECE1371

16

M-Step Symmetric Quantizer

$$\Delta = 2, (nlev = M + 1)$$

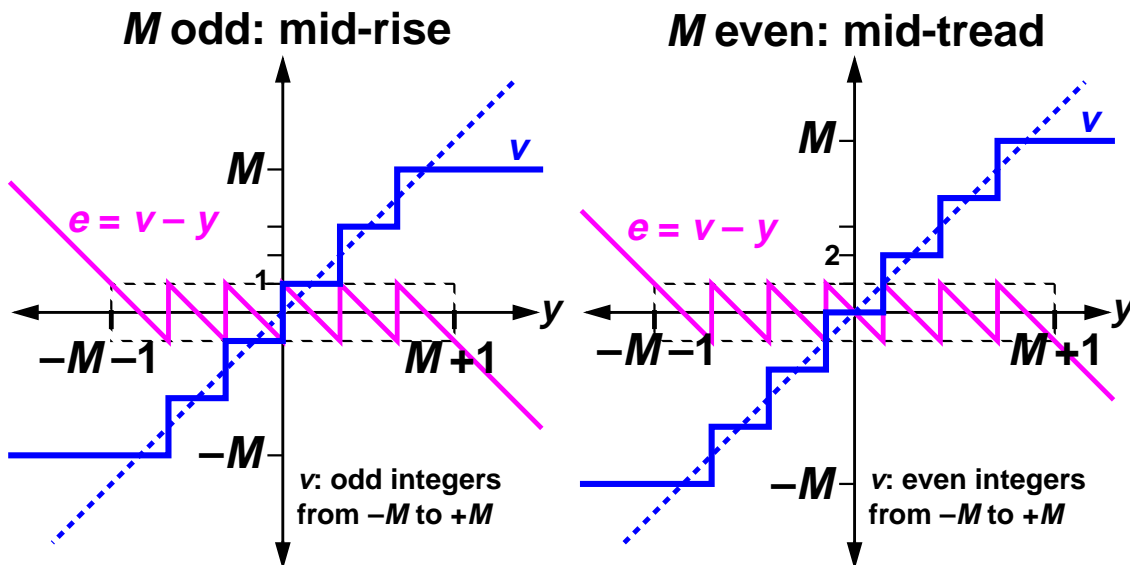

- No-overload range: $|y| \leq nlev \Rightarrow |e| \leq \Delta/2 = 1$

ECE1371

17

Inductive Proof of $\|h\|_1$ Criterion

- Assume STF = 1 and $(\forall n)(|u(n)| \leq u_{max})$
- Assume $|e(i)| \leq 1$ for $i < n$. [Induction Hypothesis]

$$\begin{aligned} |y(n)| &= \left| u(n) + \sum_{i=1}^{\infty} h(i) e(n-i) \right| \\ &\leq u_{max} + \sum_{i=1}^{\infty} |h(i)| |e(n-i)| \\ &\leq u_{max} + \sum_{i=1}^{\infty} |h(i)| = u_{max} + \|h\|_1 - 1 \end{aligned}$$

$$\text{Then } u_{max} = nlev + 1 - \|h\|_1$$

$$\Rightarrow |y(n)| \leq nlev$$

$$\Rightarrow |e(n)| \leq 1$$

- So by induction $|e(i)| \leq 1$ for all $i > 0$

ECE1371

18

More General NTF

- Instead of $NTF(z) = A(z)/B(z)$ with $B(z) = z^n$, use a more general $B(z)$

Roots of B are the poles of the NTF and must be inside the unit circle.

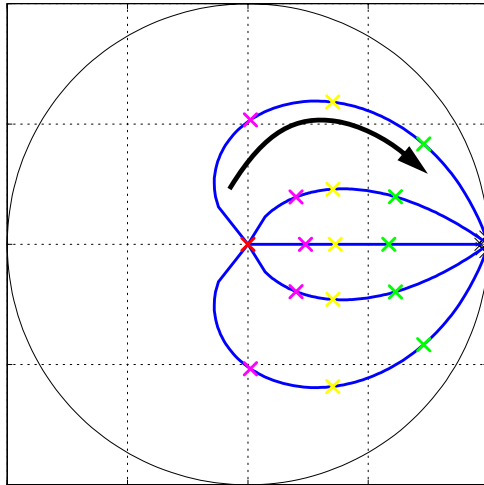

Moving the poles away from $z = 1$ toward $z = 0$ makes the gain of the NTF approach unity.

ECE1371

19

The Lee Criterion for Stability in a 1-bit Modulator: $\|H\|_{\infty} \leq 2$ [Wai Lee, 1987]

- The measure of the “gain” of H is the maximum magnitude of H over frequency, aka the *infinity-norm* of H : $\|H\|_{\infty} \equiv \max_{\omega \in [0, 2\pi]} |H(e^{j\omega})|$

Q: Is the Lee criterion necessary for stability?

No. MOD2 is stable (for DC inputs less than FS) but $\|H\|_{\infty} = 4$.

Q: Is the Lee criterion sufficient to ensure stability?

No. There are lots of counter-examples, but $\|H\|_{\infty} \leq 1.5$ often works.

ECE1371

20

Simulated SQNR vs. $\|H\|_\infty$

5th-order NTFs; 1-b Quant.; OSR = 32

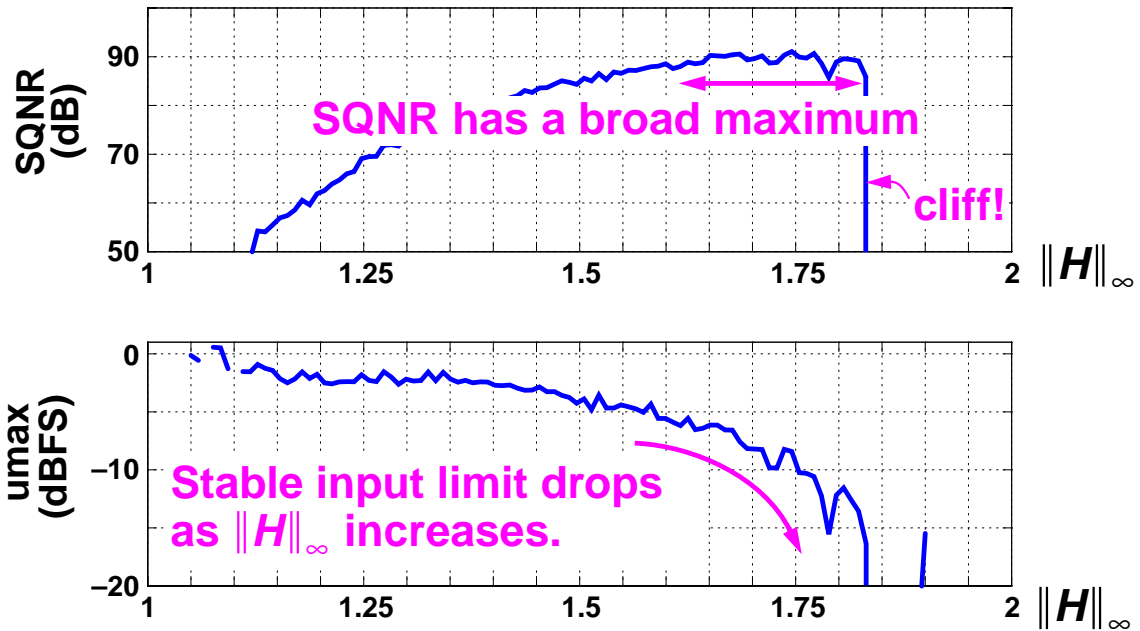

ECE1371

21

SQNR Limits— 1-bit Modulation

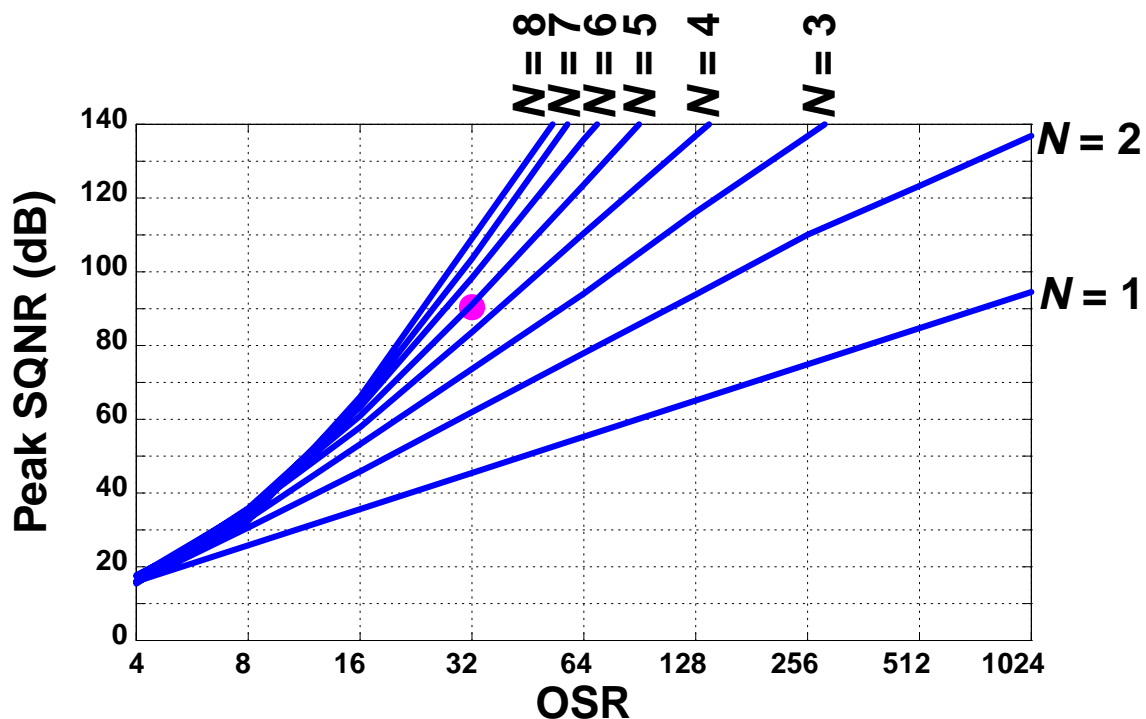

ECE1371

22

SQNR Limits for 2-bit Modulators

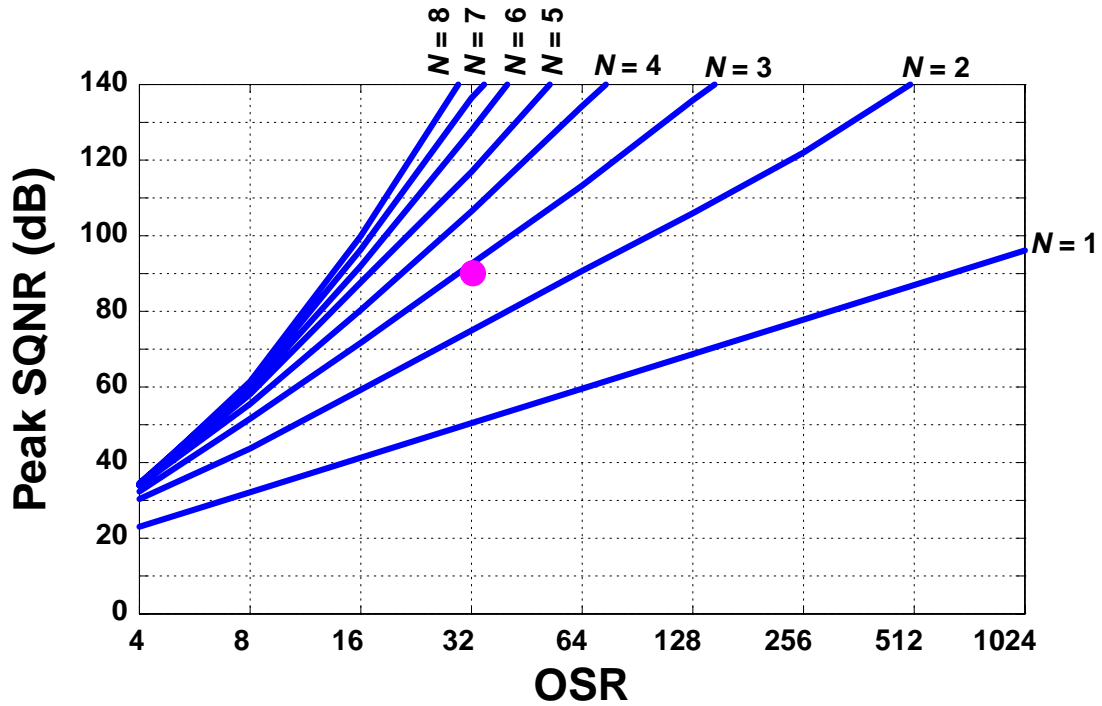

SQNR Limits for 3-bit Modulators

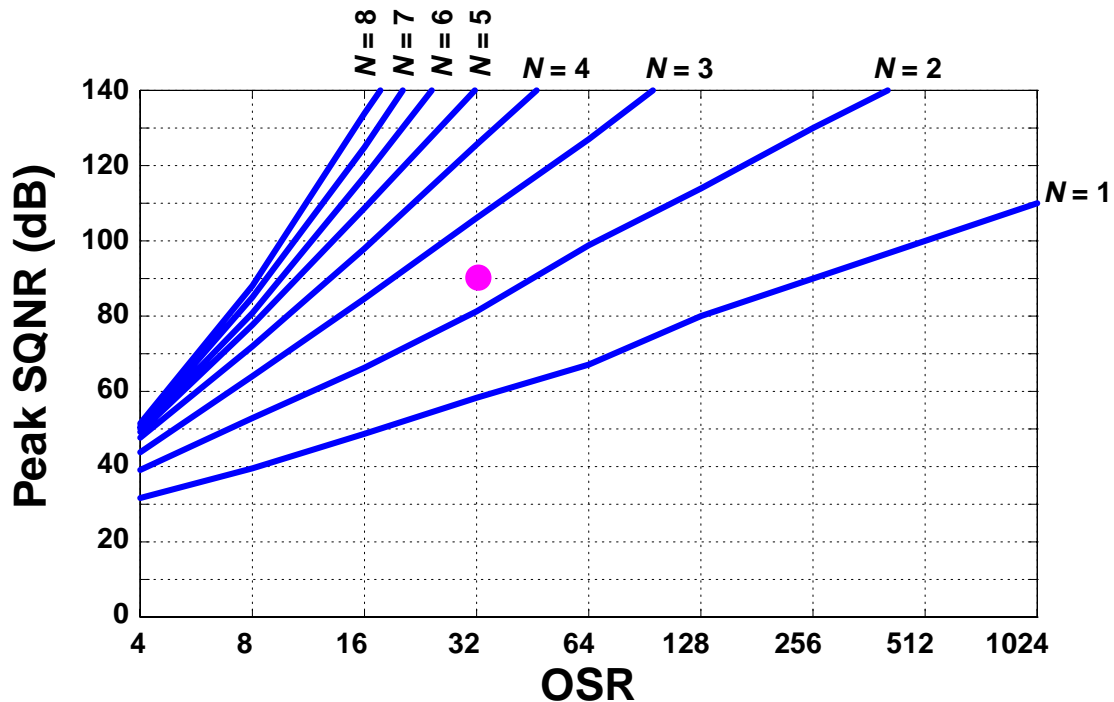

Generic Single-Loop $\Delta\Sigma$ ADC

- Linear Loop Filter + Nonlinear Quantizer:

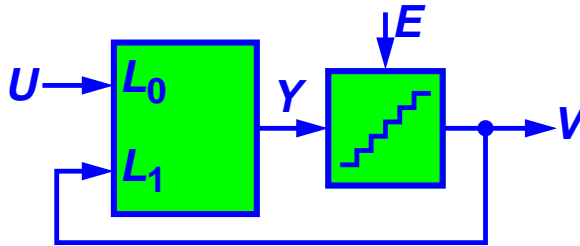

$$\begin{aligned}
 Y &= L_0 U + L_1 V \\
 V &= Y + E
 \end{aligned}
 \Rightarrow V = STF \cdot U + NTF \cdot E, \text{ where}$$

$$NTF = \frac{1}{1 - L_1} \quad \& \quad STF = L_0 \cdot NTF$$

Inverse Relations:
 $L_1 = 1 - 1/NTF, L_0 = STF / NTF$

ECE1371

25

$\Delta\Sigma$ Toolbox

<http://www.mathworks.com/matlabcentral/fileexchange>
 Search for "Delta Sigma Toolbox"

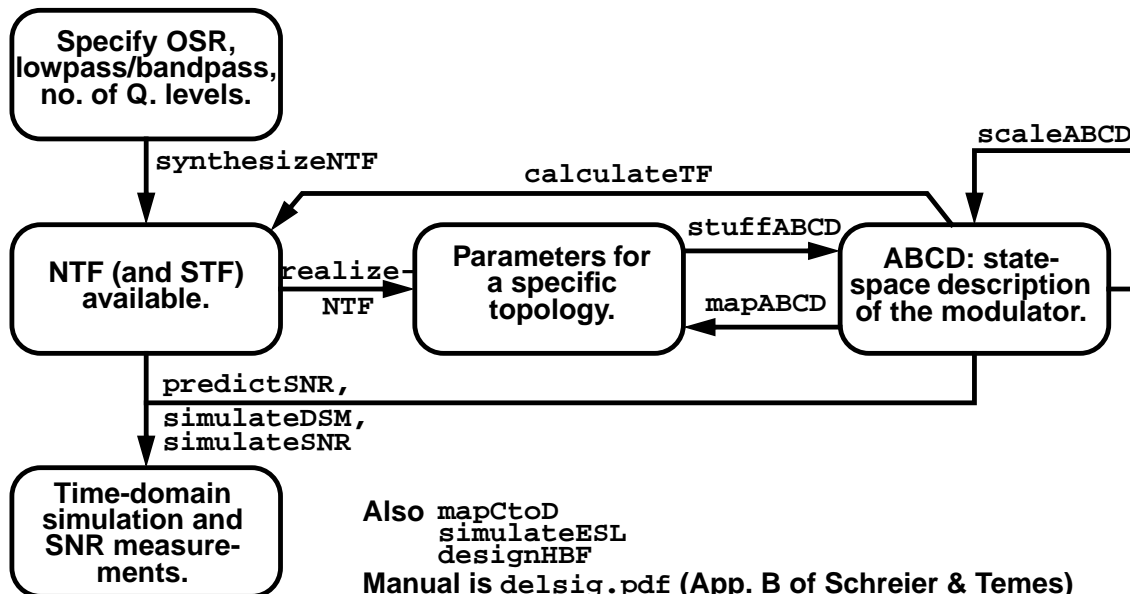

ECE1371

26

$\Delta\Sigma$ Toolbox Modulator Model

Modulator:

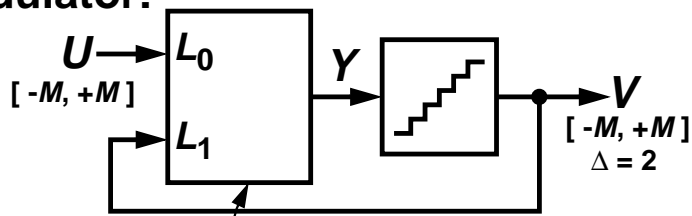

$$NTF = \frac{1}{1 - L_1}$$

$$STF = \frac{L_0}{1 - L_1}$$

Loop filter can be specified by NTF or by ABCD, a state-space representation

Quantizer:

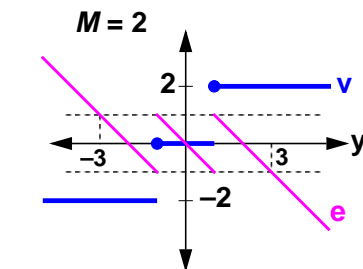
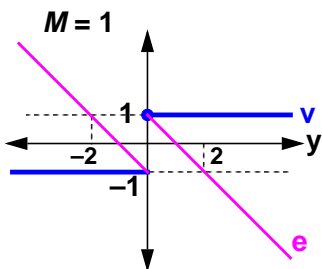

Mid-tread quantizer;
v: even integers $[-M, +M]$

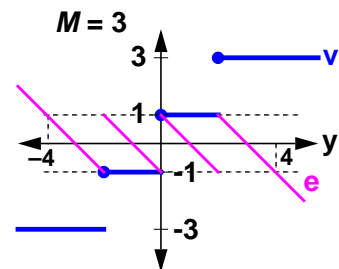

Mid-rise quantizer;
v: odd integers $[-M, +M]$

NTF Synthesis

`synthesizeNTF`

- **Not all NTFs are realizable**
Causality requires $h(0) = 1$, or, in the frequency domain, $H(\infty) = 1$. Recall $H(z) = h(0)z^0 + h(1)z^{-1} + \dots$
- **Not all NTFs yield stable modulators**
Rule of thumb for single-bit modulators:
 $\|H\|_{\infty} < 1.5$ [Lee].
- **Can optimize NTF zeros to minimize the mean-square value of H in the passband**
- **The NTF and STF share poles, and in some modulator topologies the STF zeros are not arbitrary**
Restrict the NTF such that an all-pole STF is maximally flat. (Almost the same as Butterworth poles.)

Lowpass Example [dsdemo1]

5th-order NTF, all zeros at DC

- Pole/Zero diagram:

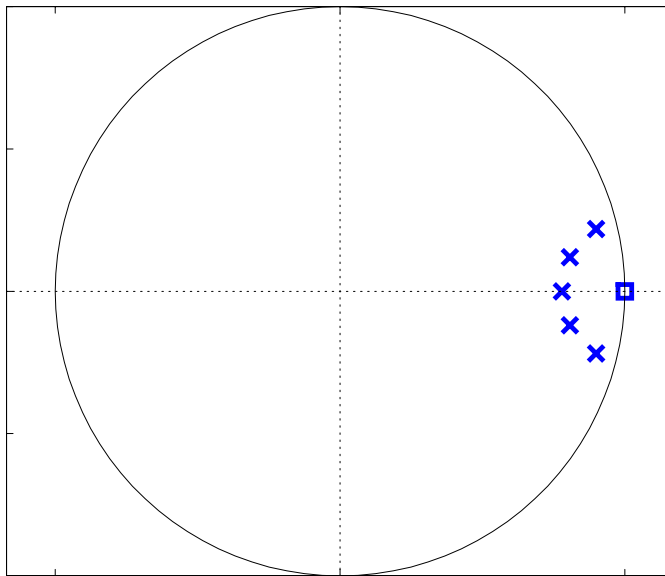

```
OSR = 32;
H = synthesizNTF(5);
plotPZ(H);

f = linspace(0,0.5);
z = exp(2i*pi*f);
H_z = evalTF(H,z);
plot(f,dbv(H_z));
g = rmsGain(H,0,0.5/OSR)
```

ECE1371

29

Lowpass NTF

Out-of-band gain = 1.5

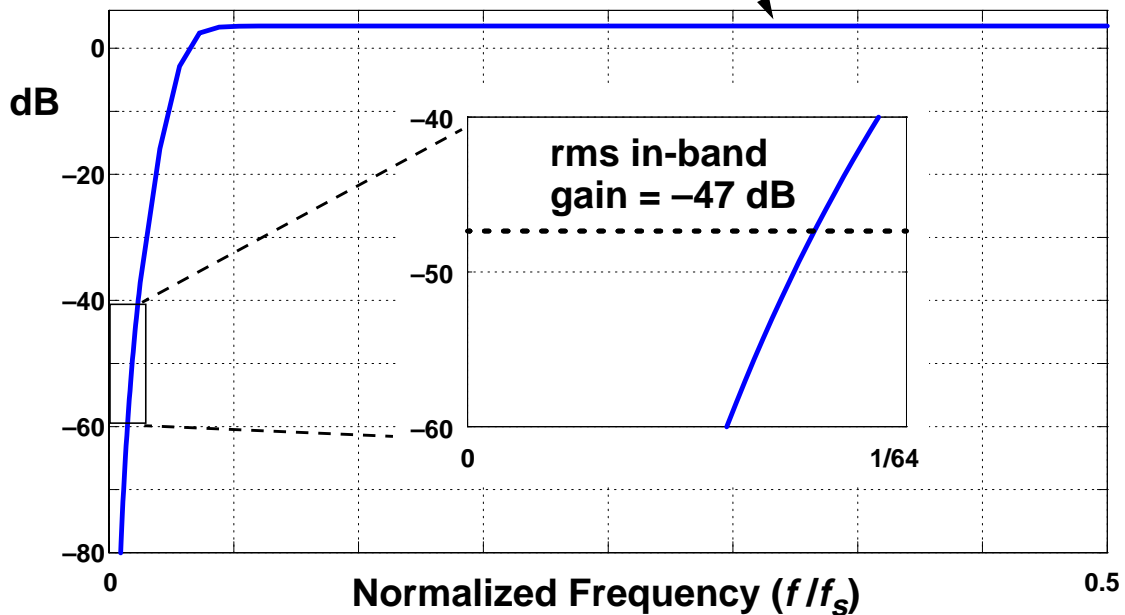

ECE1371

30

Improved 5th-Order Lowpass NTF

Zeros optimized for OSR=32

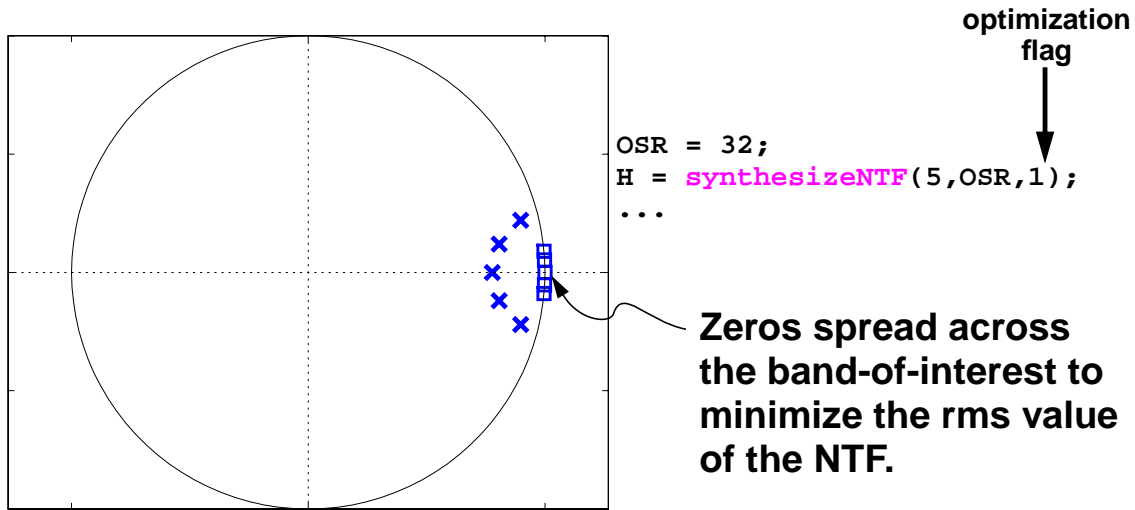

Improved NTF

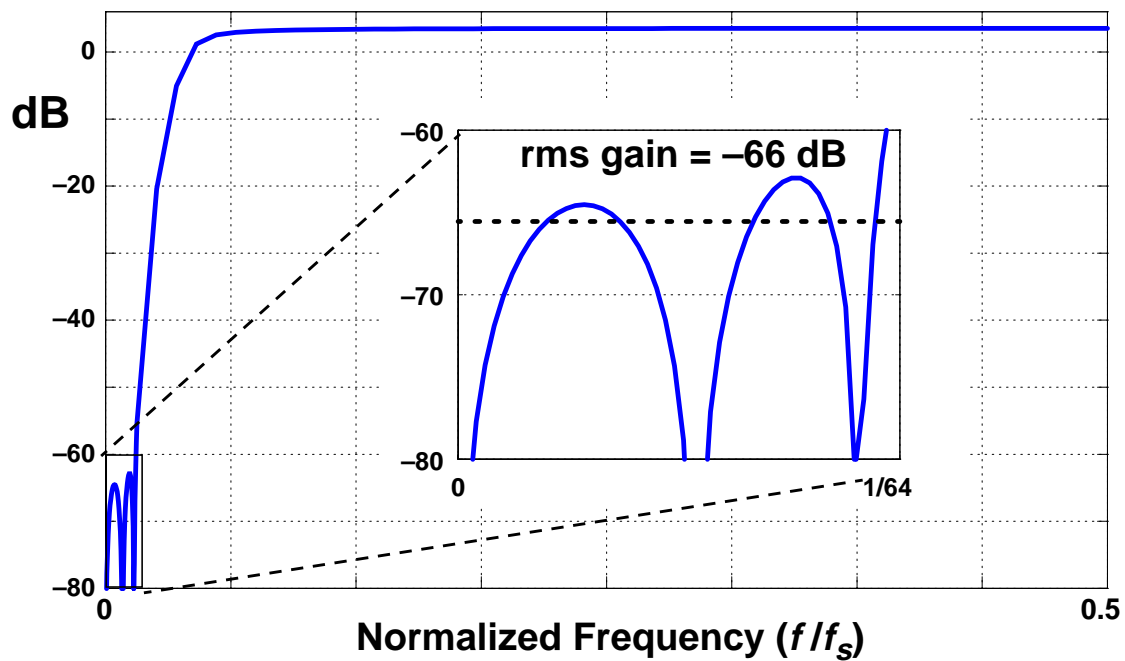

Bandpass Example

```
OSR = 64;
f0 = 1/6;
H=synthesizeNTF(6,OSR,1,[],f0);...
```

center frequency

[] or NaN means use default value, i.e. Hinf = 1.5

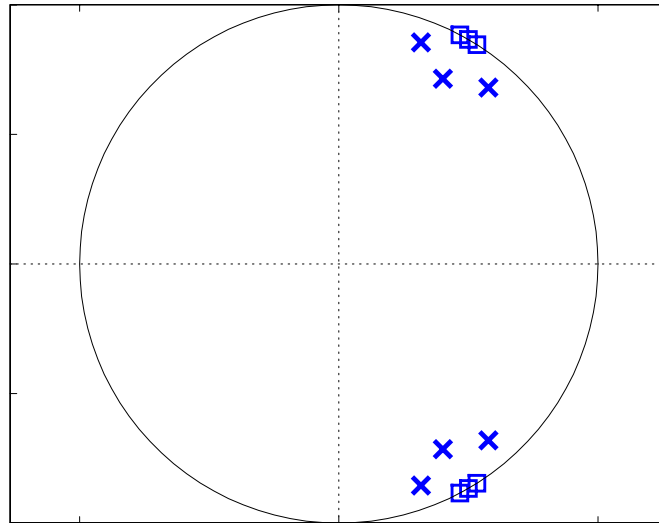

Bandpass NTF and STF

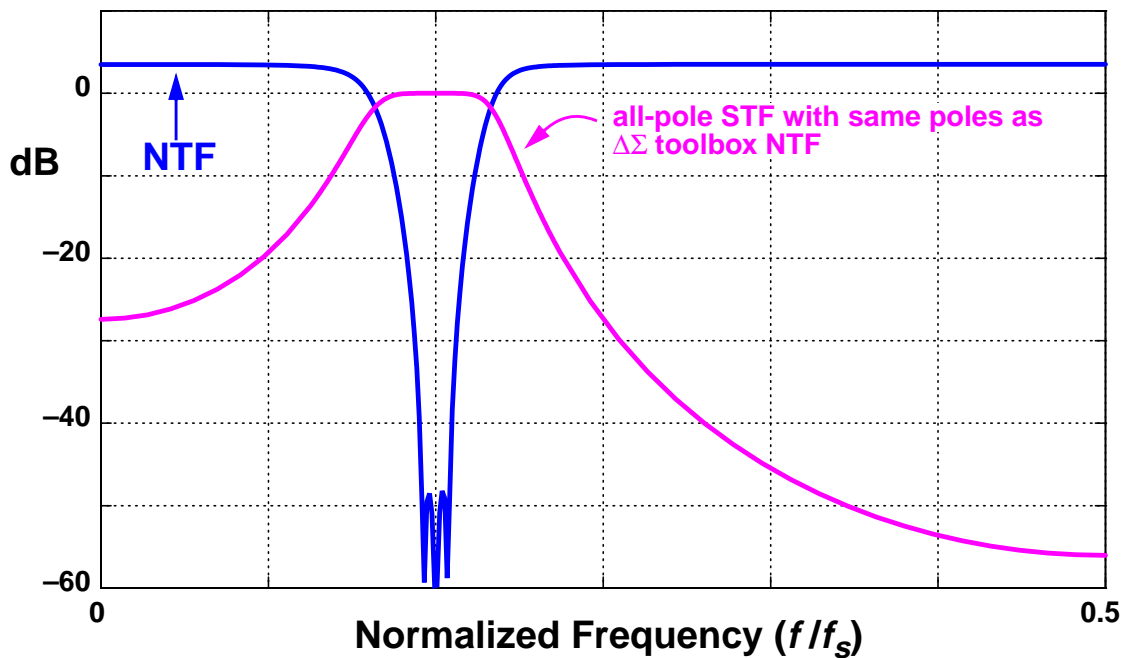

Summary: NTF Selection

- If OSR is high, a single-bit modulator may work
- To improve SQNR,
 - Optimize zeros,
 - Increase $\|H\|_{\infty}$, or
 - Increase order.
- If SQNR is insufficient, must use a multi-bit design
 - Can turn all the above knobs to enhance performance.
- Feedback DAC assumed to be ideal

ECE1371

35

NTF-Based Simulation [dsdemo2]

```
order=5; OSR=32;  
ntf = synthesizNTF(order,OSR,1);  
N=2^17; fbin=959; A=0.5; % 128K points  
input = A*sin(2*pi*fbin/N*[0:N-1]);  
output = simulatedSM(input,ntf);  
spec = fft(output.*ds_hann(N)/(N/4));  
plot(dbv(spec(1:N/(2*OSR))));
```

- In mex form; 128K points in < 0.1 sec

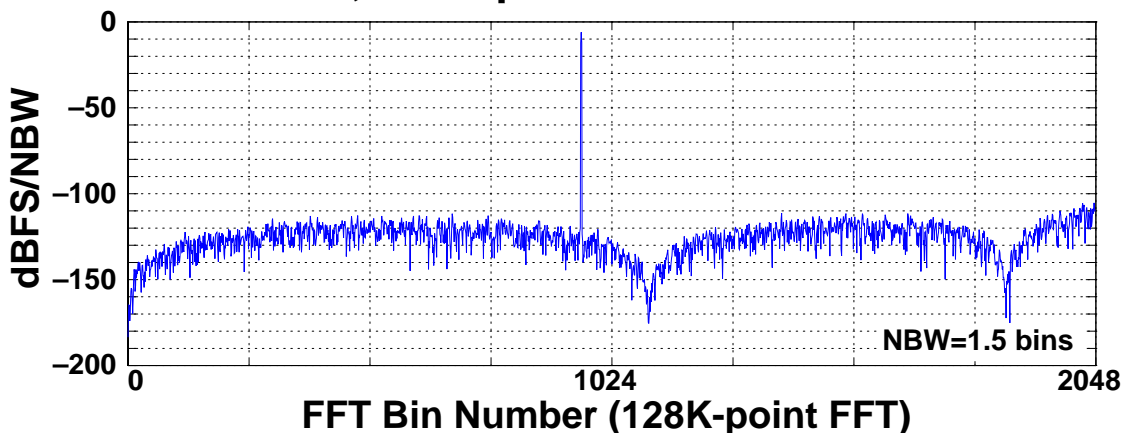

ECE1371

36

Simulation Example Cont'd

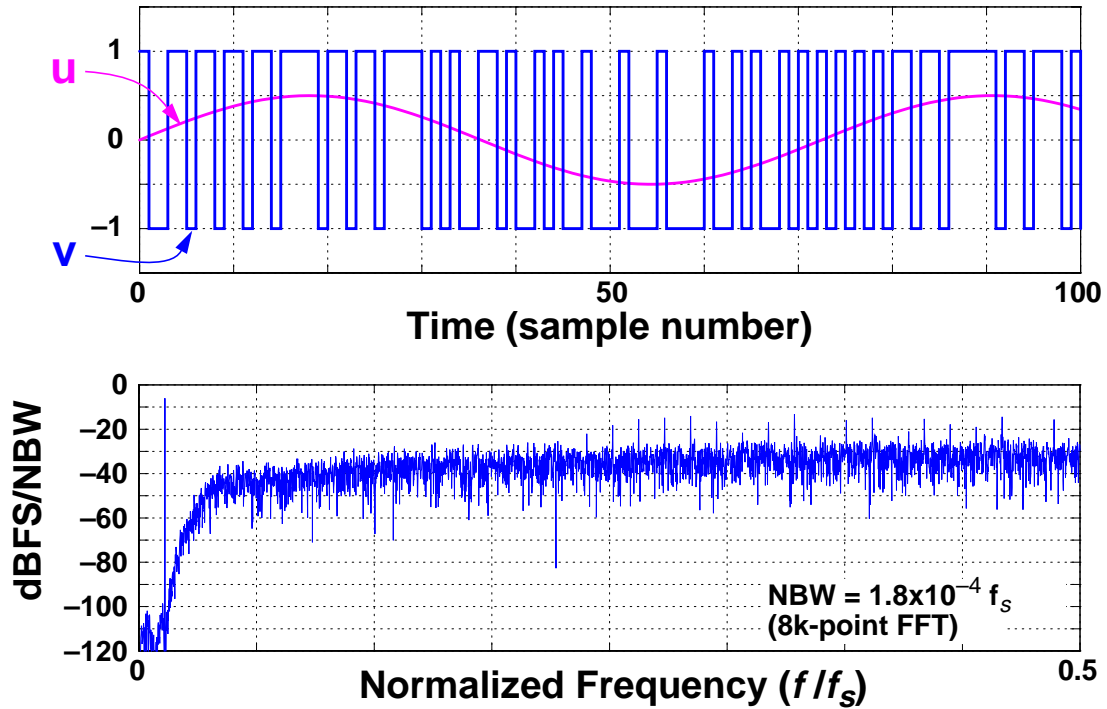

ECE1371

37

SNR vs. Amplitude: `simulateSNR`

```
[snr amp] = simulateSNR(ntf,OSR);  
plot(amp,snr,'b-^');
```

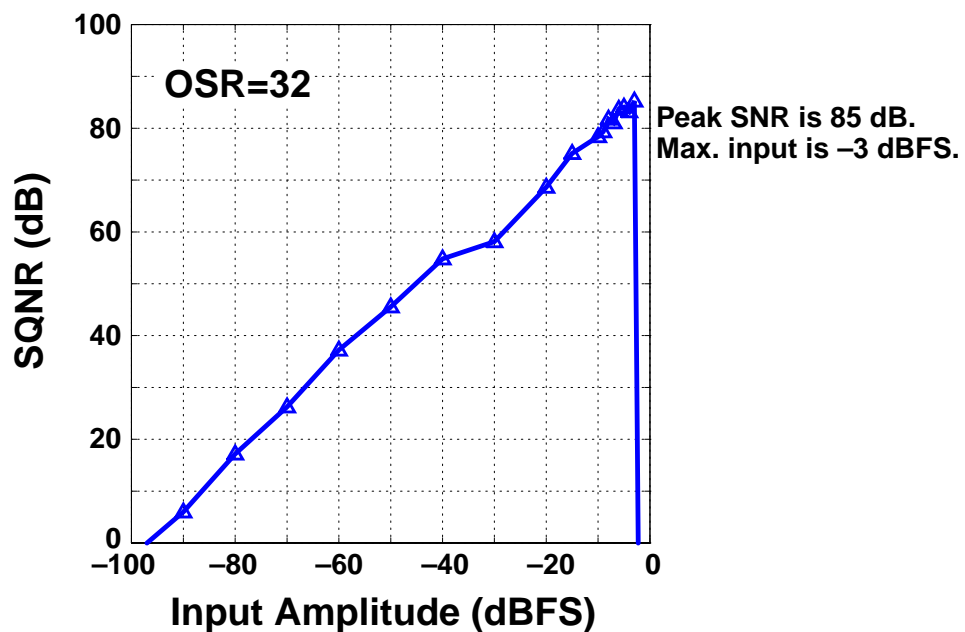

ECE1371

38

MOD2 Expanded

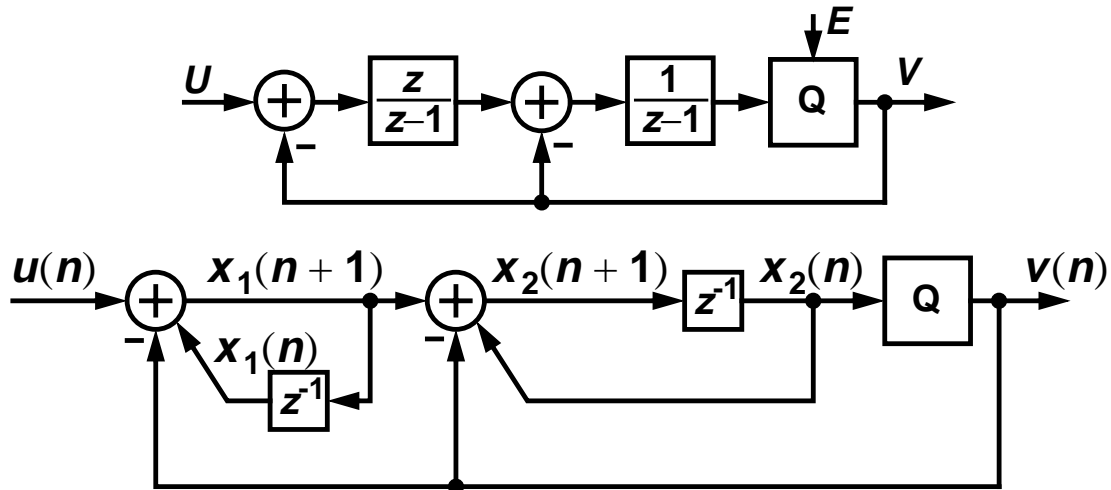

Difference Equations:

$$v(n) = Q(x_2(n))$$

$$x_1(n+1) = x_1(n) - v(n) + u(n)$$

$$x_2(n+1) = x_2(n) - v(n) + x_1(n+1)$$

ECE1371

39

Example Matlab™ Code

```
function [v] = simulateMOD2(u)
    x1 = 0;
    x2 = 0;
    for i = 1:length(u)
        v(i) = quantize( x2 );
        x1 = x1 + u(i) - v(i);
        x2 = x2 + x1 - v(i);
    end
    return
```

```
function v = quantize( y )
    if y >= 0
        v = 1;
    else
        v = -1;
    end
    return
```

ECE1371

40

NLCOTD: True Single-Phase Dynamic FF

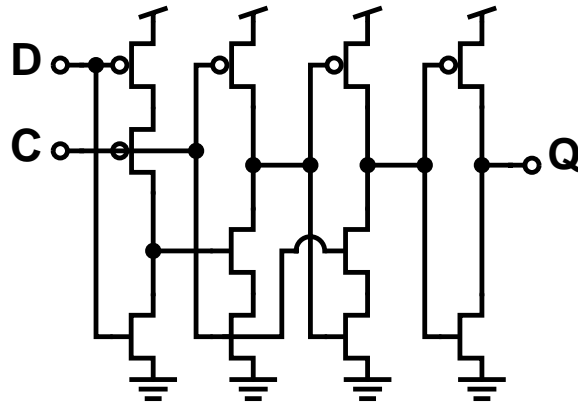

- + Clock not inverted anywhere
- + Small
- + Fast

ECE1371

41

TSPFF Operation

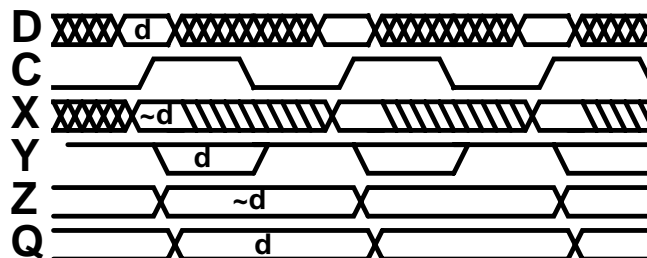
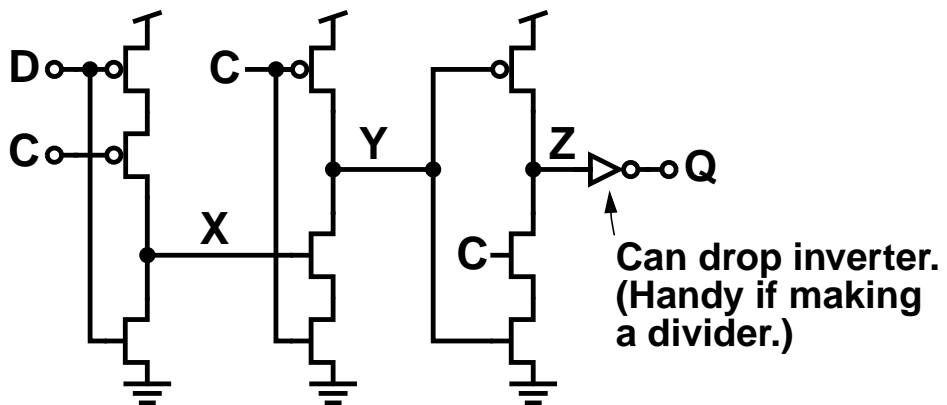

ECE1371

42

TSPFF Gotchas

- **Leakage:**
Won't work if clock is too slow.
Possible high current if clock is stopped.
 Need to add devices to hold the dynamic nodes at a safe value.
- **No positive feedback**
 Vulnerable to metastability.